



Scan QR Code for installation and operation manual



72" SUMMIT LINEAR OPEN LINEAR LUXURY FIREPLACE

UNIT DIMENSIONS

Front Width: 77 3/4"

Height: 46 13/16"

Depth: 19 7/8"

BTUs: SML-72BR-VEN (NG): 60,000 – 90,000
 SML-72BR-VEP (LP): 50,000 – 90,000
 SML-72BRT-VEN (NG): 60,000 – 95,000
 SML-72BRT-VEP (LP): 40,000 – 85,000

FRONT PHYSICAL DIMENSIONS

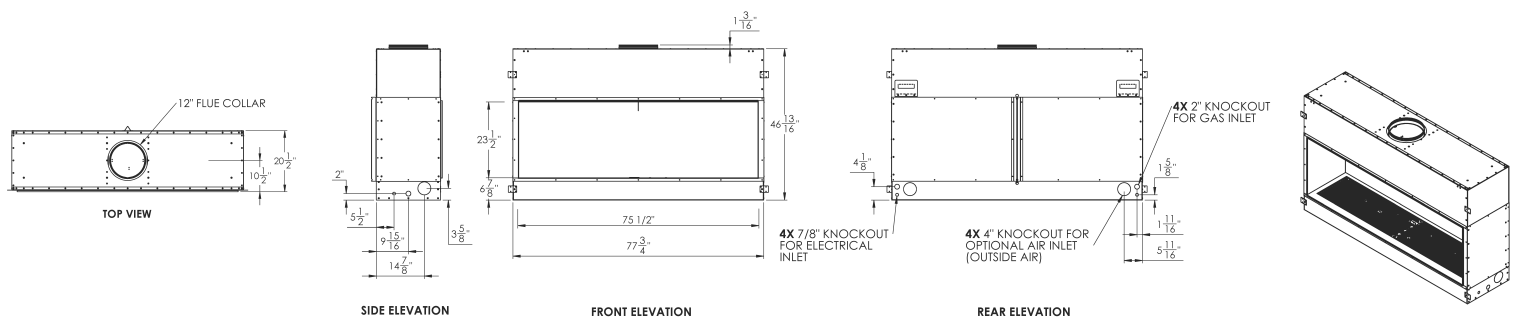

FIREPLACE BURNER OPTIONS

BEDROCK CONTEMPORARY

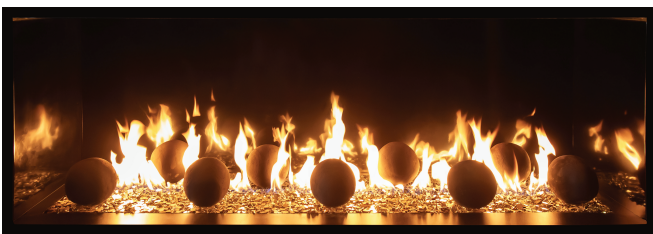

Must add 1/2" reflective glass or lava granules (5 lbs/foot)

— Optional

6" Cannonballs in black, gray, or white

72" Western Driftwood Linear Log Set, 13 pieces

BEDROCK TRADITIONAL WITH GLOWFIRE™ LOGS



Must add 1/2" reflective glass or lava granules (5 lbs/foot)

Driftwood GlowFire™ logs included.

FIREPLACE PANELS

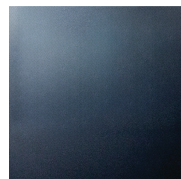

BLACK GLOSS

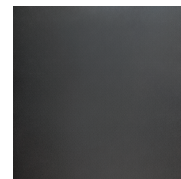

BLACK MATTE



BLACK FLUTED FIBER

VIEWING REDUCTION KIT

Viewing reduction kits are available as an add-on to reduce the viewing area by 6" in height, from 24" to 18" high. The kit included the firebox reduction panel and side drywall stops.

*If installing as a corner view or bay corner(s), reduction kits are required.

FRONT VIEW

FRAMING DIMENSIONS

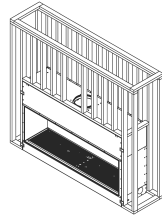

Width: 78 1/8" | **Height:** 47" | **Depth:** 20 1/2" | **Weight:** 395 lbs
Bottom to Drywall Stop: 6 3/4" | **Viewing Area:** 74 1/4"

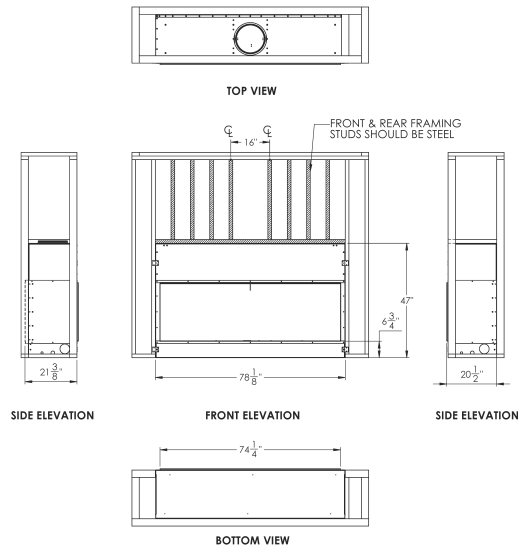

LEFT VIEW

FRAMING DIMENSIONS

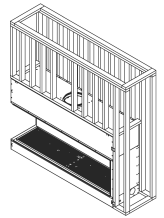

Reverse for right view

Width: 78 1/8" | **Height:** 47" | **Depth:** 20 1/2" | **Weight:** 395 lbs
Bottom to Drywall Stop: 6 3/4" | **Viewing Area:** 74 1/4"

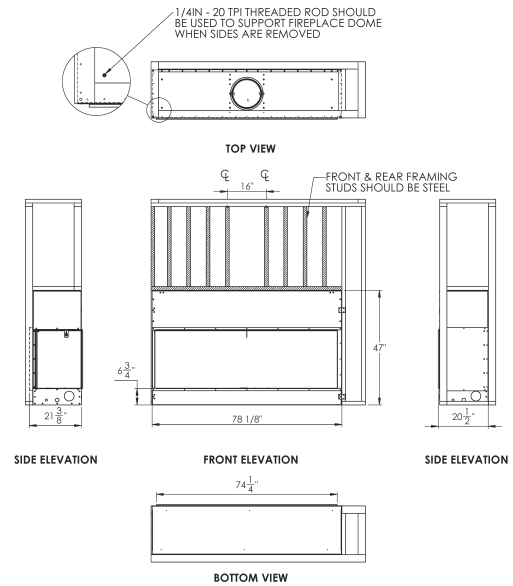

BAY VIEW

FRAMING DIMENSIONS

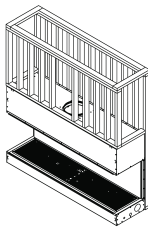

Width: 78 1/8" | **Height:** 47" | **Depth:** 20 1/2" | **Weight:** 395 lbs
Bottom to Drywall Stop: 6 3/4" | **Viewing Area:** 74 1/4"

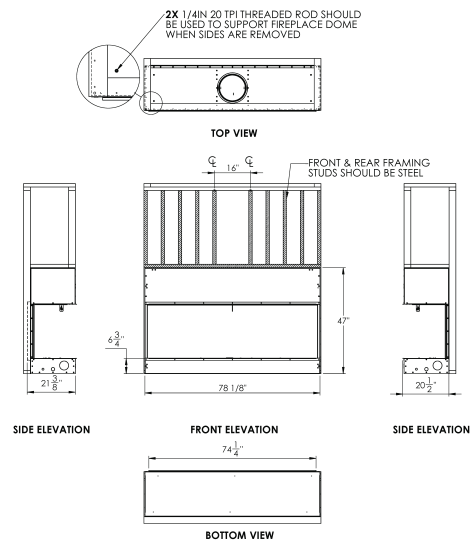

CORNER VIEW

FRAMING DIMENSIONS

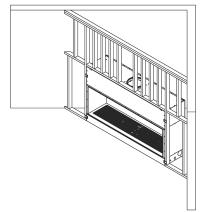

Width: 78 1/8" | **Height:** 47" | **Wall to Wall:** 121 3/4" | **Weight:** 395 lbs
Bottom to Drywall Stop: 6 3/4" | **Viewing Area:** 74 1/4" | **Angle:** 86 1/8"

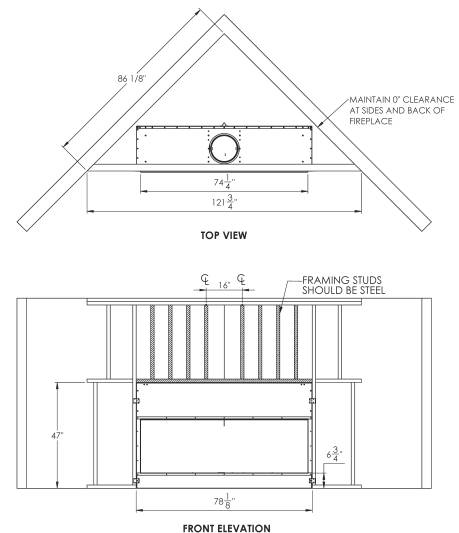

MINIMUM CLEARANCE TO COMBUSTIBLES

Back and sides of fireplaces	0" minimum
Floor	0" minimum
Perpendicular wall to opening	19" minimum
Top of fireplace	0" or top of studs minimum
Chimney outer pipe surface	1" minimum

VENTING

12" B-Vent
 Minimum Height 14"
 No more than two 45° offsets

MANTEL CLEARANCES

A combustible mantel shelf may be installed a maximum of 12 (22.9 cm) from the wall.

The figures below show the minimum allowable distances from various combustible mantel components in relation to the fireplace opening.

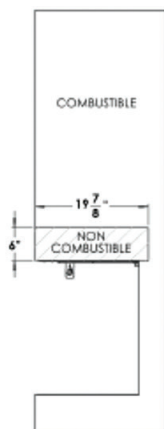

Figure 15 - Finishing Material - Side View

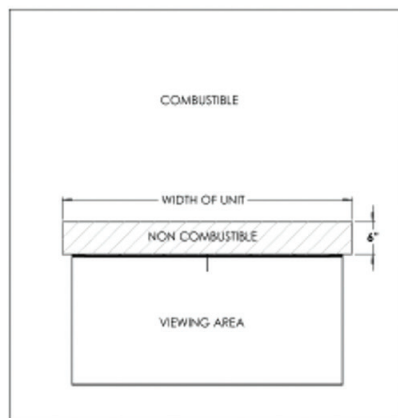

Figure 16 - Finishing Material - Front View

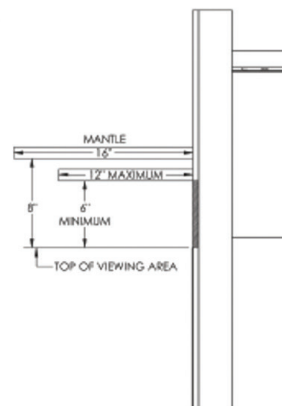

Figure 18 - Mantle Heights

PRODUCT CODES

USA	ANSI Z21.50.2019
CAN	CSA 2.22.2019

The product information provided is not complete and is subject to change without notice.

To avoid the risk of fire and potential injury, product installation must adhere strictly to instructions contained in the Installation and Operation Manual.